

# QUICK COUPLINGS

## KQ-A A - Adapter female thread

Unit:mm

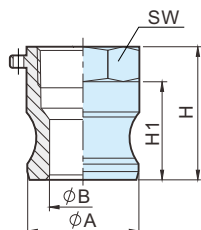

inch	NW	φA	φB	H1	H	SW
1/2"	15	32.0	21.2	28.0	38.0	33.0
3/4"	20	32.0	21.2	28.0	38.0	33.0
1"	25	36.7	23.8	33.5	46.5	41.0
1-1/4"	32	45.5	28.6	40.0	55.0	48.0
1-1/2"	40	53.4	36.0	42.5	58.5	56.0
2"	50	63.0	45.5	47.5	62.3	67.5
2-1/2"	65	75.7	56.4	50.0	68.0	83.0
3"	80	91.5	73.5	51.0	70.0	96.5
4"	100	119.5	100.0	53.0	76.0	124.0

## KQ-B B - Coupler male thread

Unit:mm

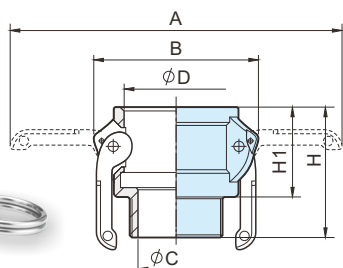

inch	NW	A	B	φC	φD	H1	H
1/2"	15	115.0	57.0	15.0	32.4	30.0	48.0
3/4"	20	115.0	57.0	21.2	32.4	30.0	48.0
1"	25	137.0	65.6	25.0	37.3	39.0	61.0
1-1/4"	32	183.0	77.0	28.0	46.0	46.0	68.0
1-1/2"	40	191.0	85.0	39.0	54.0	48.0	70.5
2"	50	201.0	96.0	50.0	63.7	53.0	78.7
2-1/2"	65	213.0	110.4	58.0	76.5	58.0	86.0
3"	80	267.0	133.0	73.2	92.2	58.0	89.0
4"	100	296.0	166.0	97.0	120.2	63.0	97.0

## KQ-C C - Coupler hose shank

Unit:mm

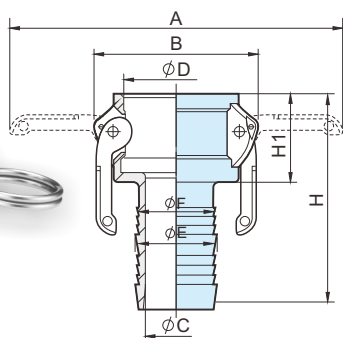

inch	NW	A	B	φC	φD	φE	φF	H1	H
1/2"	15	-	-	-	-	-	-	-	-
3/4"	20	115.0	57.0	13.6	32.4	20.7	19.4	30.0	80.0
1"	25	137.0	65.6	20.0	37.3	27.0	25.8	39.0	99.0
1-1/4"	32	183.0	77.0	25.8	46.0	33.9	32.9	46.0	110.0
1-1/2"	40	191.0	85.0	31.3	54.0	40.5	38.6	48.0	114.0
2"	50	201.0	96.0	43.8	63.7	52.0	51.0	53.0	129.0
2-1/2"	65	213.0	110.4	55.7	76.5	66.8	-	58.0	151.0
3"	80	267.0	133.0	68.0	92.2	79.0	-	58.0	160.0
4"	100	296.0	166.0	92.0	120.2	104.8	-	63.0	176.0

## KQ-D D - Coupler female thread

Unit:mm

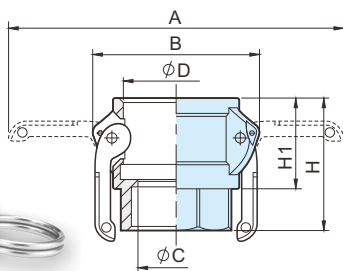

inch	NW	A	B	φC	φD	H1	H
1/2"	15	115.0	57.0	17.0	32.4	30.0	46.0
3/4"	20	115.0	57.0	20.0	32.4	30.0	50.0
1"	25	137.0	65.6	26.0	37.3	39.0	60.0
1-1/4"	32	183.0	77.0	34.5	46.0	46.0	66.0
1-1/2"	40	191.0	85.0	40.0	54.0	48.0	70.5
2"	50	201.0	96.0	50.0	63.7	53.0	76.0
2-1/2"	65	213.0	110.4	61.0	76.5	58.0	82.0
3"	80	267.0	133.0	75.0	92.2	58.0	86.0
4"	100	296.0	166.0	100.0	120.2	63.0	92.0

# QUICK COUPLINGS

## KQ-E E - Adapter hose shank

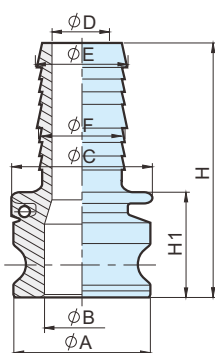

Unit:mm

inch	NW	$\phi A$	$\phi B$	$\phi C$	$\phi D$	$\phi E$	$\phi F$	H1	H
1/2"	15	-	-	-	-	-	-	-	-
3/4"	20	32.0	21.2	33.0	13.6	20.7	19.4	37.0	87.0
1"	25	36.7	23.8	39.0	20.0	27.0	25.8	44.0	104.0
1-1/4"	32	45.5	28.6	48.0	25.8	33.9	32.9	51.0	115.0
1-1/2"	40	53.4	36.0	56.0	31.3	40.5	38.6	52.0	118.0
2"	50	63.0	45.5	66.0	43.8	52.0	51.0	56.0	132.0
2-1/2"	65	75.7	55.7	80.0	55.7	66.8	-	64.0	156.0
3"	80	91.5	73.2	101.0	68.0	79.0	-	66.0	169.0
4"	100	119.5	91.0	130.0	92.0	104.8	-	68.0	180.0

## KQ-F F - Adapter male thread

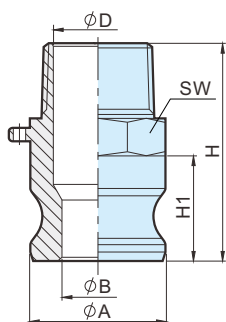

Unit:mm

inch	NW	$\phi A$	$\phi B$	$\phi D$	H1	H	SW
1/2"	15	32.0	21.2	15.0	28.0	56.0	33.0
3/4"	20	32.0	21.2	21.2	28.0	56.0	33.0
1"	25	36.7	23.8	23.8	33.5	69.0	41.0
1-1/4"	32	45.5	28.6	33.0	40.0	77.0	48.0
1-1/2"	40	53.4	36.0	39.6	42.5	80.0	56.0
2"	50	63.0	45.5	50.0	47.5	89.0	65.0
2-1/2"	65	75.7	56.4	56.4	50.0	98.0	82.5
3"	80	91.5	73.2	77.5	51.0	101.0	95.8
4"	100	119.5	100.0	100.0	53.0	114.0	124.0

## KQ-DC DC - Dustcap

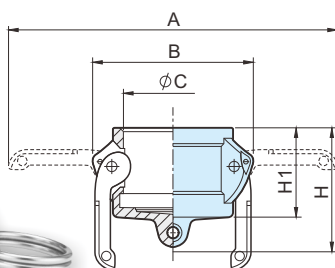

Unit:mm

inch	NW	A	B	$\phi C$	H1	H
1/2"	15	-	-	-	-	-
3/4"	20	115.0	57.0	32.4	30.0	40.0
1"	25	137.0	65.6	37.3	39.0	53.0
1-1/4"	32	183.0	77.0	46.0	46.0	61.0
1-1/2"	40	191.0	85.0	54.0	48.0	64.0
2"	50	201.0	96.0	63.7	53.0	68.0
2-1/2"	65	213.0	110.4	76.5	58.0	82.0
3"	80	267.0	133.0	92.2	58.0	83.0
4"	100	296.0	166.0	120.2	63.0	93.0

## KQ-DP DP - Dustplug

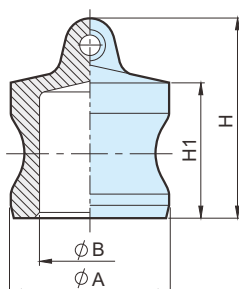

Unit:mm

inch	NW	$\phi A$	$\phi B$	H1	H
1/2"	15	-	-	-	-
3/4"	20	32.0	21.2	25.0	35.0
1"	25	36.7	23.8	30.5	44.5
1-1/4"	32	45.5	28.6	37.7	52.7
1-1/2"	40	53.4	36.0	38.7	53.7
2"	50	63.0	45.5	42.8	57.8
2-1/2"	65	75.7	56.4	46.0	71.0
3"	80	91.5	73.2	46.0	72.0
4"	100	119.5	100.0	50.0	76.0